

2022/2023
產品目錄

Well Bloom
ITALY



CONTENTS

目錄

- 座廁 Water Closet 3
- 面盆 Wash Basin 4-7
- 龍頭套裝 Faucet Package 8-25
- 廚房龍頭 Kitchen Faucet 26-28
- 花灑柱套裝 Hand Shower Set 29-30
- 花灑頭 Hand Shower 31
- 花灑喉 Shower Hose 32
- 雨淋花灑 Rainshower 33-34
- 浴室配件 Accessories 35-43



Water Closet 座廁



WB690

特短自由咀分體座廁

連油壓廁板

(無邊框設計)

625x375x790mm

建議零售價：\$2,340

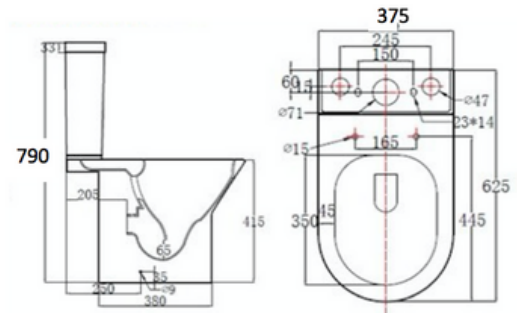

WB662A

自由咀分體座廁

連油壓廁板

(可避6"石壘/橫喉)

685x360x760mm

建議零售價：\$1,980

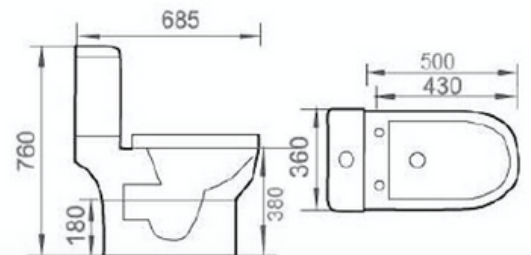

Wash Basin 面盆



P5538BD/RG/MG

黑拉絲不銹鋼坐檯面盆
玫瑰金不銹鋼坐檯面盆
拉絲金不銹鋼坐檯面盆
550x380x100mm



建議零售價：\$3,280



P3636BD/RG/MG

黑拉絲不銹鋼坐檯面盆
玫瑰金不銹鋼坐檯面盆
拉絲金不銹鋼坐檯面盆
360x110mm



建議零售價：\$2,950



P4040BD/RG/MG

黑拉絲不銹鋼坐檯面盆
玫瑰金不銹鋼坐檯面盆
拉絲金不銹鋼坐檯面盆
400x400x100mm



建議零售價：\$2,950



Wash Basin 面盆



A426-MP
啞白色坐檯面盆
A426-CBKM
啞黑色坐檯面盆
455x320x135mm

建議零售價：\$1,750



A420-MP
啞白色坐檯面盆
A420CBKM
啞黑色坐檯面盆
A420-CGRM
啞灰色坐檯面盆
420x420x145mm
建議零售價：\$1,750



A423-MP
啞白色坐檯面盆
A423-CBKM
啞黑色坐檯面盆
A423-CGRM
啞灰色坐檯面盆
385x385x140mm

建議零售價：\$1,280



A422-MP
啞白色坐檯面盆
A422CBKM
啞黑色坐檯面盆
A422-CGRM
啞灰色坐檯面盆
500x400x135mm
建議零售價：\$1,860



A423-P76
大理石紋方形坐檯面盆
390x390x135mm
建議零售價：\$1,480



F009BS
大理石紋長方形坐檯面盆
510x390x150mm
建議零售價：\$1,860



F006BS
大理石紋圓形坐檯面盆
410x410x150mm
建議零售價：\$1,280



WB075MW
啞白色圓形坐檯面盆
WB075PB
啞黑色圓形坐檯面盆
360x114mm
建議零售價：\$1,280

Wash Basin 面盆



A420

亮白色坐檯面盆

420x420x145mm

建議零售價：\$900



A423

亮白色坐檯面盆

385x385x140mm

建議零售價：\$700



A426

亮白色坐檯面盆

455x320x135mm

建議零售價：\$1,160



A037

亮白色坐檯面盆

380x380x130mm

建議零售價：\$760



A022

亮白色坐檯面盆

480x370x130mm

建議零售價：\$800



A082

亮白色坐檯面盆

410x335x145mm

建議零售價：\$760



A091

亮白色坐檯面盆

415x155mm

建議零售價：\$800



A025

亮白色坐檯面盆

420x155mm

建議零售價：\$680



1080PB

啞黑色坐檯面盆

400x155mm

建議零售價：\$1,200

Wash Basin 面盆



B20 檯下盆
340x290x165mm
建議零售價：\$600



A20 檯下盆
400x300x180mm
建議零售價：\$850

B21 檯下盆
390x330x195mm
B32 檯下盆
420x340x195mm
建議零售價：\$700

A91 檯下盆
465x350x180mm
A92 檯下盆
500x400x180mm
建議零售價：\$950



B22
檯上盆
405x310x180mm
建議零售價：\$490



WBB05
掛牆盆
350x275x160mm
建議零售價：\$330



WB016B
掛牆盆
400x370x175mm
建議零售價：\$370



WB718
掛牆盆
450x330x190mm
建議零售價：\$550



WBB04
掛牆盆
490x350x180mm
建議零售價：\$540



WB715
掛牆盆
520x240x180mm
建議零售價：\$470

Faucet Package 龍頭套裝



1



16505
亮銀色面盆龍頭
建議零售價：\$870

2



16505A
亮銀色高身面盆龍頭
建議零售價：\$1,240

3



16555
亮銀色浴缸龍頭
建議零售價：\$1,160

4



A40C
亮銀色柱裝花灑
建議零售價：\$450

5



5009
亮銀色雨淋花灑
(可調高低)
建議零售價：\$2,480

165系列優惠組合

1+3+4	\$2,230
2+3+4	\$2,560
1+5	\$3,010
2+5	\$3,340



16523
亮銀色廚房龍頭
建議零售價：\$870

優惠價\$780 換購16523 廚房龍頭

Faucet Package 龍頭套裝



16505PB
黑色面盆龍頭
建議零售價：\$1,240



16505APB
黑色高身面盆龍頭
建議零售價：\$1,770



16555PB
黑色浴缸龍頭
建議零售價：\$1,630



3060PB
黑色柱裝花灑
建議零售價：\$1,230



5009PB
黑色雨淋花灑
(可調高低)
建議零售價：\$4,380

165系列黑色優惠組合

1+3+4	\$3,690
2+3+4	\$4,170
1+5	\$5,050
2+5	\$5,530



16523PB
黑色廚房龍頭
建議零售價：\$1,140

優惠價\$1,020 換購16523PB 黑色廚房龍頭

Faucet Package 龍頭套裝



1



16505SG

太空灰色面盆龍頭

建議零售價：\$1,380

2



16505ASG

太空灰色高身面盆龍頭

建議零售價：\$1,970

3



16555SG

太空灰色浴缸龍頭

建議零售價：\$1,830

4



3060SG

太空灰色柱裝花灑

建議零售價：\$1,520

5



5009SG

太空灰色雨淋花灑

(可調高低)

建議零售價：\$4,380

165太空灰系列優惠組合

1+3+4 \$4,250

2+3+4 \$4,780

1+5 \$5,180

2+5 \$5,710



16523SG

太空灰色廚房龍頭

建議零售價：\$1,250

優惠價\$1,120 換購16523SG 廚房龍頭

Faucet Package 龍頭套裝

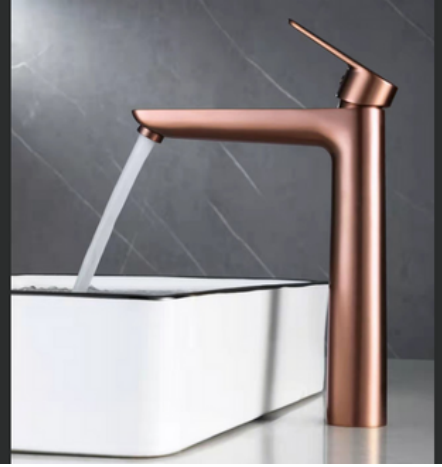

1



16505RM

拉絲玫瑰金色面盆龍頭

建議零售價：\$1,380

2



16505ARM

拉絲玫瑰金色高身面盆龍頭

建議零售價：\$1,970

3



16555RM

拉絲玫瑰金色浴缸龍頭

建議零售價：\$1,830

4



3060RM

拉絲玫瑰金色柱裝花灑

建議零售價：\$1,520

5



5009RM

拉絲玫瑰金色雨淋花灑

(可調高低)

建議零售價：\$4,380

165玫瑰拉絲金系列優惠組合

1+3+4 \$4,250

2+3+4 \$4,780

1+5 \$5,180

2+5 \$5,710



16523RM

拉絲玫瑰金色廚房龍頭

建議零售價：\$1,250

優惠價\$1,120 換購16523RM 廚房龍頭

Faucet Package 龍頭套裝



1



7003C
亮銀色面盆龍頭
建議零售價：\$690

2



7001C
亮銀色高身面盆龍頭
建議零售價：\$930

3



7007C
亮銀色浴缸龍頭
建議零售價：\$930

4



7016C
亮銀色柱裝花灑
建議零售價：\$740

5



7012C
亮銀色雨淋花灑
(可調高低)
建議零售價：\$3,100

700系列優惠組合

1+3+4	\$2,120
2+3+4	\$2,340
1+5	\$3,410
2+5	\$3,620

優惠價\$670 換購7006C 廚房龍頭



7006C
亮銀色廚房龍頭
建議零售價：\$750



B39C
5速花灑頭
優惠價\$80 (原價\$160)

升級花灑頭

Faucet Package 龍頭套裝



Enjoy The Life
Enjoy The Difference

1



7003MB
黑色面盆龍頭
建議零售價：\$920

2



7001MB
黑色高身面盆龍頭
建議零售價：\$1,230

3



7007MB
黑色浴缸龍頭
建議零售價：\$1,230

4



7016MB
黑色柱裝花灑
建議零售價：\$920

5



7012MB
黑色雨淋花灑
(可調高低)
建議零售價：\$4,050

700系列黑色優惠組合

1+3+4	\$2,760
2+3+4	\$3,040
1+5	\$4,470
2+5	\$4,750

優惠價\$1,100 換購7006MB 廚房龍頭



7006MB
黑色廚房龍頭
建議零售價：\$1,230



升級花灑頭

B39PB
黑色5速花灑頭
優惠價\$200 (原價\$300)

Faucet Package 龍頭套裝



1



7003MW
白色面盆龍頭
建議零售價：\$920

2



7001MW
白色高身面盆龍頭
建議零售價：\$1,230

3



7007MW
白色浴缸龍頭
建議零售價：\$1,230

4



7016MW
白色柱裝花灑
建議零售價：\$920

5



7012MW
白色雨淋花灑
(可調高低)
建議零售價：\$4,050

700系列白色優惠組合

1+3+4	\$2,760
2+3+4	\$3,040
1+5	\$4,470
2+5	\$4,750

優惠價\$1,100 換購7006MW 廚房龍頭



7006MW
白色廚房龍頭
建議零售價：\$1,230



B39MW
白色5速花灑頭
優惠價\$200 (原價\$300)

升級花灑頭

Faucet Package 龍頭套裝



1



7003RG

玫瑰金色面盆龍頭

建議零售價：\$1,320



2

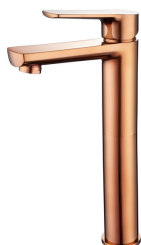

7001RG

玫瑰金色高身面盆龍頭

建議零售價：\$1,880



3



7007RG

玫瑰金色浴缸龍頭

建議零售價：\$1,780



700系列玫瑰金優惠組合

1+3+4 \$3,870

2+3+4 \$4,370

1+5 \$6,400

2+5 \$6,910

香檳金色(CG) 及拉絲金色(MG)同價

4



7016RG

玫瑰金色柱裝花灑

建議零售價：\$1,200



5



7012RG

玫瑰金色雨淋花灑

(可調高低)

建議零售價：\$5,800



優惠價\$1,580 換購7006RG 廚房龍頭

另有香檳金色(CG) 及拉絲金色(MG)



7006RG

玫瑰金色廚房龍頭

建議零售價：\$1,760



升級花灑頭

B39RG

玫瑰金色5速花灑頭

優惠價\$200 (原價\$300)

Faucet Package 龍頭套裝



1



3003BD
黑拉絲色面盆龍頭
建議零售價：\$930

2



3001BD
黑拉絲色高身面盆龍頭
建議零售價：\$1,200

3



3007BD
黑拉絲色浴缸龍頭
建議零售價：\$1,280

4



3016BD
黑拉絲色柱裝花灑
建議零售價：\$840

5



3012BD
黑拉絲色雨淋花灑
(可調高低)
建議零售價：\$5,300

300黑拉絲系列優惠組合

1+3+4	\$2,740
2+3+4	\$2,980
1+5	\$5,600
2+5	\$5,850

優惠價\$1,080 換購3006BD 廚房龍頭



3006BD
黑拉絲色廚房龍頭
建議零售價：\$1,200



B70BD
黑拉絲色5速花灑頭
優惠價\$300 (原價\$380)

升級花灑頭

Faucet Package 龍頭套裝

1



3003WL
砂鋼色面盆龍頭
建議零售價：\$890

2



3001WL
砂鋼色高身面盆龍頭
建議零售價：\$1,140

3



3007WL
砂鋼色浴缸龍頭
建議零售價：\$1,220

4



3016WL
砂鋼色柱裝花灑
建議零售價：\$780

5



3012WL
砂鋼色雨淋花灑
(可調高低)
建議零售價：\$4,980

300砂鋼系列優惠組合

1+3+4	\$2,600
2+3+4	\$2,820
1+5	\$5,280
2+5	\$5,500

優惠價\$1,020 換購3006WL 廚房龍頭



3006WL
砂鋼色廚房龍頭
建議零售價：\$1,140



B39WL
砂鋼色5速花灑頭
優惠價\$200 (原價\$300)

升級花灑頭

Faucet Package 龍頭套裝



5002
銀黑色面盆龍頭
建議零售價：\$1,200



5003
銀黑色高身面盆龍頭
建議零售價：\$1,660



5008
銀黑色浴缸龍頭
建議零售價：\$1,660



AH966CB
銀黑色柱裝花灑
建議零售價：\$650



5009
亮銀色雨淋花灑
(可調高低)
建議零售價：\$2,480

500系列優惠組合

1+3+4	\$3,160
2+3+4	\$3,570
1+5	\$3,310
2+5	\$3,720

優惠價\$1,490 換購5006 廚房龍頭



5006
銀黑色廚房龍頭
建議零售價：\$1,660

Faucet Package 龍頭套裝



1



4002
銀白色面盆龍頭
建議零售價：\$1,200

2



4003
銀白色高身面盆龍頭
建議零售價：\$1,660

3



4008
銀白色浴缸龍頭
建議零售價：\$1,660

4



AH966CW
銀白色花灑柱裝花灑
建議零售價：\$650

5



5009
亮銀色雨淋花灑
(可調高低)
建議零售價：\$2,480

400系列優惠組合

1+3+4	\$3,160
2+3+4	\$3,570
1+5	\$3,310
2+5	\$3,720

優惠價\$1,490 換購4006 廚房龍頭



4006
銀白色廚房龍頭
建議零售價：\$1,660

Faucet Package 龍頭套裝



1



10001B

黑色面盆龍頭

建議零售價：\$990

2



10002B

黑色高身面盆龍頭

建議零售價：\$1,390

3



40001B

黑色浴缸龍頭

建議零售價：\$1,280

4



30001B

黑色花灑龍頭

建議零售價：\$1,160

5



A60PB

黑色柱裝花灑

建議零售價：\$600

6



43001B

黑色雨淋花灑

(可調高低)

建議零售價：\$3,600

2087系列優惠組合

1+3+5 \$2,580

2+3+5 \$2,940

1+4+5 \$2,470

2+4+5 \$2,830

1+6 \$4,130

2+6 \$4,490

優惠價\$1,770 換購LX22031PB 廚房龍頭



LX22031PB

可拉出式黑色廚房龍頭

建議零售價：\$1,970

Faucet Package 龍頭套裝

1



7003C

亮銀色面盆龍頭

建議零售價：\$690

2



06-43016

亮銀色花灑龍頭

建議零售價：\$770

3



06-33016

亮銀色搖擺咀浴缸龍頭

建議零售價：\$1,020

4



WL64003

亮銀色轉駁式雨淋花灑

(可調高低)

建議零售價：\$2,200

06優惠組合

2+4 \$2,670

1+2+4 \$3,290

3+4 \$2,890

1+3+4 \$3,510

1



7003MB

黑色面盆龍頭

建議零售價：\$920

2



06-43016PB

黑色花灑龍頭

建議零售價：\$1,080

3



06-33016PB

黑色搖擺咀浴缸龍頭

建議零售價：\$1,530

4



WL64003PB

黑色轉駁式雨淋花灑

(可調高低)

建議零售價：\$3,290

06黑色優惠組合

2+4 \$3,930

1+2+4 \$4,760

3+4 \$4,330

1+3+4 \$5,160

Faucet Package 龍頭套裝



1



9825-D67
瀑布式面盆龍頭
(龍頭高度: 110mm)
建議零售價: \$1,760

2



9825A-D67
瀑布式中高面盆龍頭
(龍頭高度: 170mm)
建議零售價: \$1,990

3



9825B-D67
瀑布式高身面盆龍頭
(龍頭高度: 260mm)
建議零售價: \$2,200

4



8105-D67
瀑布式浴缸龍頭
(包括花灑頭及花灑喉)
建議零售價: \$3,670

5



070115
全銅花灑企柱
建議零售價: \$380

9825優惠組合

1+4	\$4,880
2+4	\$5,090
3+4	\$5,280
1+4+5	\$5,220
2+4+5	\$5,430
3+4+5	\$5,620



Faucet Package 龍頭套裝



1
16121
亮銀色面盆龍頭
建議零售價：\$670

 此型號已獲香港水務署
認可證書：C20190349



2
16126
亮銀色高身面盆龍頭
建議零售價：\$850

 此型號已獲香港水務署
認可證書：C20190529



3
16123
亮銀色浴缸龍頭
建議零售價：\$950

 此型號已獲香港水務署
認可證書：C20190386



4
A39C
亮銀色柱裝花灑
建議零售價：\$330



5
16125
亮銀色廚房龍頭
建議零售價：\$730

 此型號已獲香港水務署
認可證書：C20190388

161系列優惠組合	
1+3+4	\$1,750
2+3+4	\$1,910
1+3+4+5	\$2,410
2+3+4+5	\$2,570



1
0002
亮銀色面盆龍頭
建議零售價：\$600

 此型號已獲香港水務署
認可證書：C20190289



2
0008
亮銀色浴缸龍頭
建議零售價：\$860

 此型號已獲香港水務署
認可證書：C20190290



3
A39C
亮銀色柱裝花灑
建議零售價：\$330



4
0006
亮銀色廚房龍頭
建議零售價：\$780

 此型號已獲香港水務署
認可證書：C20190289



5
5008F
亮銀色轉駁式雨淋花灑
建議零售價：\$1,620

000系列優惠組合	
1+2+3	\$1,610
1+2+3+4	\$2,310
1+2+5	\$2,770
1+2+4+5	\$3,470

Faucet Package 龍頭套裝



1



13605

亮銀色面盆龍頭

建議零售價：\$530



此型號已獲香港水務署
認可證書：C20210919

2



13668

亮銀色花灑龍頭

建議零售價：\$460

3

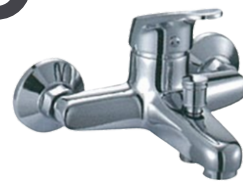

13655

亮銀色浴缸龍頭

建議零售價：\$560



此型號已獲香港水務署
認可證書：C20211167

4



A39C

亮銀色柱裝花灑

建議零售價：\$330

5



13623

亮銀色廚房龍頭

建議零售價：\$580



此型號已獲香港水務署
認可證書：C20210424

136系列優惠組合

1+2+4	\$1,180
1+3+4	\$1,270
1+2+4+5	\$1,710
1+3+4+5	\$1,800



Faucet Package 龍頭套裝

1



2002
亮銀色面盆龍頭
建議零售價：\$760

2



2003
亮銀色高身面盆龍頭
建議零售價：\$920

3



2008
亮銀色浴缸龍頭
建議零售價：\$920

4



2006
亮銀色廚房龍頭
建議零售價：\$880

1



3002
亮銀色面盆龍頭
建議零售價：\$760

2



3003
亮銀色高身面盆龍頭
建議零售價：\$920

3



3008
亮銀色浴缸龍頭
建議零售價：\$920

4



3006
亮銀色廚房龍頭
建議零售價：\$880

5



A39C
亮銀色柱裝花灑
建議零售價：\$330



2003A/3003A
加長出水咀
亮銀色高身面盆龍頭
建議零售價：\$1,100

升级加長出水咀
+ \$100

200/300優惠組合

1+3+5	\$1,800
2+3+5	\$1,950
1+3+4+5	\$2,600
2+3+4+5	\$2,740

Kitchen Faucet 廚房龍頭



0006
亮銀色廚房龍頭
建議零售價：\$780
此型號已獲香港水務署
認可證書：C20190289



X2007
亮銀色廚房龍頭
建議零售價：\$760



16125
亮銀色廚房龍頭
建議零售價：\$730
此型號已獲香港水務署
認可證書：C20190388



638WL
砂鋼色廚房龍頭
建議零售價：\$800
此型號已獲香港水務署
認可證書：C20170759



7006C
亮銀色廚房龍頭
建議零售價：\$750



8761-D50
亮銀色廚房龍頭
建議零售價：\$1,080



16523
亮銀色廚房龍頭
建議零售價：\$870



2006
亮銀色廚房龍頭
3006
亮銀色廚房龍頭
建議零售價：\$880

Kitchen Faucet 廚房龍頭



5006
銀黑色廚房龍頭

4006
銀白色廚房龍頭
建議零售價：\$1,660



16523PB
黑色廚房龍頭
建議零售價：\$1,140



16523SG
太空灰色廚房龍頭

16523RM
拉絲玫瑰金色廚房龍頭
建議零售價：\$1,250



7006MB
黑色廚房龍頭

7006MW
白色廚房龍頭
建議零售價：\$1,230



7006RG
玫瑰金色廚房龍頭
建議零售價：\$1,760



7006CG
香檳金色廚房龍頭

7006MG
拉絲金色廚房龍頭
建議零售價：\$1,760



3006WL
砂鋼色廚房龍頭
建議零售價：\$1,140



3006BD
黑拉絲色廚房龍頭
建議零售價：\$1,200

Kitchen Faucet 廚房龍頭



3901BS
黑石廚房龍頭
建議零售價：\$1,180



3901WS
白石廚房龍頭
建議零售價：\$1,180



9934CB
記憶軟管黑色廚房龍頭
建議零售價：\$880



9934CW
記憶軟管白色廚房龍頭
建議零售價：\$880



9934WL
砂鋼色記憶軟管廚房龍頭
建議零售價：\$720



LX22031
可拉出式亮銀色廚房龍頭
建議零售價：\$1,280



LX22031PB
可拉出式黑色廚房龍頭
建議零售價：\$1,970



8726
亮銀色星盆花灑混合龍頭
建議零售價：\$2,090

8726WL
砂鋼色星盆花灑混合龍頭
建議零售價：\$2,320

Hand Shower Set

花灑柱套裝



A39C
亮銀色柱裝花灑
(包括皂碟)
建議零售價：\$330



A40C
亮銀色柱裝花灑
(包括皂碟)
建議零售價：\$450



7016C
亮銀色柱裝花灑
建議零售價：\$740

升级花灑頭
+\$80



7016RG
玫瑰金色柱裝花灑
建議零售價：\$1,200

升级花灑頭
+\$200



7016CG
香檳金色柱裝花灑
7016MG
拉絲金色柱裝花灑

建議零售價：\$1,200

升级花灑頭
+\$200



7016MB
黑色柱裝花灑
7016WH
白色柱裝花灑

建議零售價：\$920

升级花灑頭
+\$200



Hand Shower Set 花灑柱套裝



3016WL
砂鋼色柱裝花灑
建議零售價：\$780

升级花灑頭
+ \$200



3016BD
黑拉絲色柱裝花灑
建議零售價：\$840

升级花灑頭
+ \$300



A60PB
黑色柱裝花灑
建議零售價：\$600



AH966CB
銀黑色柱裝花灑
AH966CW
銀白色柱裝花灑

建議零售價：\$650



3060PB
黑色柱裝花灑
建議零售價：\$1,230



3060SG
太空灰色柱裝花灑
3060RM
拉絲玫瑰金色柱裝花灑

建議零售價：\$1,520



Hand Shower 花灑頭



B8237C
單速花灑頭
建議零售價：\$90



B8238C
單速花灑頭
建議零售價：\$90



H951
單速花灑頭
建議零售價：\$90



B40C
3速花灑頭
建議零售價：\$130



B8142C
5速花灑頭
建議零售價：\$130



B26C
5速花灑頭
建議零售價：\$130



B42C
5速花灑頭
建議零售價：\$130



B39C
5速花灑頭
建議零售價：\$160



B39WL
砂鋼色5速花灑頭
(另有其他顏色)
建議零售價：\$300



B60PB
黑色5速花灑頭
建議零售價：\$350



64003APB
黑色3速花灑頭
建議零售價：\$380



B70BD
黑拉絲色5速花灑頭
建議零售價：\$380



Shower Hose 花灑喉

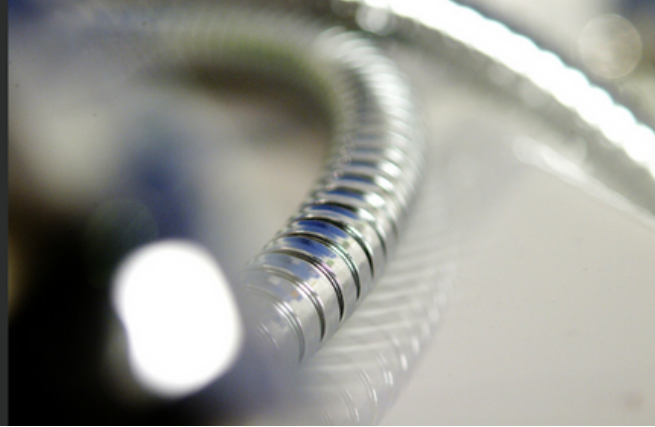

BL-BDL150
1.5m不銹鋼花灑喉
建議零售價：\$90

BL-BDL175
1.75m不銹鋼花灑喉
建議零售價：\$100

BL-BDL200
2m不銹鋼花灑喉
建議零售價：\$110



BW-G150
1.5m不銹鋼旋轉咀花灑喉
建議零售價：\$140

BW-G175
1.75m不銹鋼旋轉咀花灑喉
建議零售價：\$150

BW-G200
2m不銹鋼旋轉咀花灑喉
建議零售價：\$160



BL-GL150
1.5m包膠花灑喉
建議零售價：\$80

BL-GL175
1.75m包膠花灑喉
建議零售價：\$90

BL-GL200
2m包膠花灑喉
建議零售價：\$100



BW-ED150
1.5m高壓包膠花灑喉
建議零售價：\$180

BW-ED175
1.75m高壓包膠花灑喉
建議零售價：\$190

BW-ED200
2m高壓包膠花灑喉
建議零售價：\$200



3021PB
1.5m黑色
高壓包膠花灑喉
建議零售價：\$320



3021BD
1.5m黑拉絲色
高壓包膠花灑喉
建議零售價：\$320

Rainshower 雨淋花灑



5008F
亮銀色轉駁式雨淋花灑
建議零售價：\$1,620



WL64003
亮銀色轉駁式雨淋花灑
建議零售價：\$2,200



WL64003PB
黑色轉駁式雨淋花灑
建議零售價：\$3,290



241043A
亮銀色雨淋花灑
建議零售價：\$2,180



9005
亮銀色雨淋花灑
建議零售價：\$2,180



3012WL
砂鋼色雨淋花灑
建議零售價：\$4,980



3012BD
黑拉絲色雨淋花灑
建議零售價：\$5,300



3012PB
黑色雨淋花灑
建議零售價：\$5,300



43001B
黑色雨淋花灑
建議零售價：\$3,600

Rainshower 雨淋花灑



5009
亮銀色雨淋花灑
建議零售價：\$2,480



7012C
亮銀色雨淋花灑
建議零售價：\$3,100



7012RG
玫瑰金色雨淋花灑
7012MG
拉絲金色雨淋花灑
7012CG
香檳金色雨淋花灑
建議零售價：\$5,800



7012MB
黑色雨淋花灑
7012MW
白色雨淋花灑
建議零售價：\$4,050



5009PB
黑色雨淋花灑
5009SG
太空灰色雨淋花灑
5009RM
拉絲玫瑰金色雨淋花灑
建議零售價：\$4,380



Accessories 浴室配件



2709C
亮銀色單勾
建議零售價：\$150



2710C
亮銀色雙勾
建議零售價：\$160



9030C
亮銀色單勾
建議零售價：\$150



2708C
亮銀色毛巾環
建議零售價：\$200



9060C
亮銀色毛巾架/廁紙架
建議零售價：\$220



9061C
亮銀色廁紙架
建議零售價：\$240



7809B
亮銀色廁紙架
建議零售價：\$200



WB30
亮銀色廁紙架
建議零售價：\$320



WB60
亮銀色雙廁紙架
建議零售價：\$400



2803-24
亮銀色毛巾架
建議零售價：\$580



9020C
亮銀色單毛巾杆
建議零售價：\$350



9010C
亮銀色雙毛巾杆
建議零售價：\$500



Y1059C(200mm)
Y1105C(230mm)
亮銀色角架
建議零售價：\$250

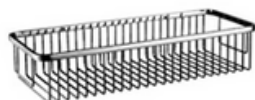

Y1043C
亮銀色置物架
400mm
建議零售價：\$280



P4B
亮銀色4勾排勾
建議零售價：\$180
P5B
亮銀色5勾排勾
建議零售價：\$200
P6B
亮銀色6勾排勾
建議零售價：\$220

Accessories 浴室配件



105WL
砂鋼色單勾
建議零售價：\$150



7608B
砂鋼色雙勾
建議零售價：\$150



9061WL
砂鋼色廁紙架
建議零售價：\$260



7609B
砂鋼色廁紙架
建議零售價：\$200



2708WL
砂鋼色毛巾環
建議零售價：\$250



9060WL
砂鋼色面巾架
建議零售價：\$240



9020WL
砂鋼色單毛巾杆
建議零售價：\$380



9010WL
砂鋼色雙毛巾杆
建議零售價：\$540



209
砂鋼色毛巾架
建議零售價：\$400



9012WL
砂鋼色毛巾架
建議零售價：\$880



Y1059WL(200mm)
Y1105WL(230mm)
砂鋼色角架
建議零售價：\$250



Y1043WL
砂鋼色置物架
400mm
建議零售價：\$280



Y19-20 (20"可摺疊)
砂鋼色四杆毛巾架
建議零售價：\$430



Y19-24 (24"可摺疊)
砂鋼色四杆毛巾架
建議零售價：\$470

314L
砂鋼色4勾排勾
建議零售價：\$180

315L
砂鋼色5勾排勾
建議零售價：\$200

316L
砂鋼色6勾排勾
建議零售價：\$220

Accessories 浴室配件



9030BD
黑拉絲色單勾
建議零售價：\$200



2708BD
黑拉絲色毛巾環
建議零售價：\$360



9061BD
黑拉絲色廁紙架
建議零售價：\$300



9060BD
黑拉絲色面巾架
建議零售價：\$300



9020BD
黑拉絲色單毛巾杆
建議零售價：\$440



9010BD
黑拉絲色雙毛巾杆
建議零售價：\$600



9012BD
黑拉絲色毛巾架
建議零售價：\$1,020



9080BD
黑拉絲色置物架
建議零售價：\$440



9030WH
白色單勾
建議零售價：\$190



9060WH
白色面巾架
建議零售價：\$280



9061WH
白色廁紙架
建議零售價：\$280



98105WH
白色廁紙架
建議零售價：\$400



98169WH
白色毛巾及置物架
建議零售價：\$480



9020WH
白色單毛巾杆
建議零售價：\$440



9010WH
白色雙毛巾杆
建議零售價：\$600

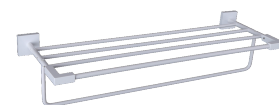

9012WH
白色毛巾架
建議零售價：\$1,020

Accessories 浴室配件



9030RG
玫瑰金色單勾
建議零售價：\$240



9060RG
玫瑰金色面巾架
建議零售價：\$350



9061RG
玫瑰金色廁紙架
建議零售價：\$360



2707RG
玫瑰金色廁紙架
建議零售價：\$480



2708RG
玫瑰金色毛巾環
建議零售價：\$360



8040RG
玫瑰金色毛巾架
建議零售價：\$360



9020RG
玫瑰金色單毛巾杆
建議零售價：\$500



9010RG
玫瑰金色雙毛巾杆
建議零售價：\$720



9012RG
玫瑰金色毛巾架
建議零售價：\$1,200



8020RG
玫瑰金色單毛巾杆
建議零售價：\$530



8010RG
玫瑰金色雙毛巾杆
建議零售價：\$560



8002RG
玫瑰金色浴室角架
建議零售價：\$460



8001RG
玫瑰金色置物架
建議零售價：\$450



8003RG
玫瑰金色置物架
建議零售價：\$450



4RG
玫瑰金色4勾排勾
建議零售價：\$300

5RG
玫瑰金色5勾排勾
建議零售價：\$380

6RG
玫瑰金色6勾排勾
建議零售價：\$460

Accessories 浴室配件



205SG
太空灰色單勾
建議零售價：\$240



2710SG
太空灰色雙勾
建議零售價：\$280



98105SG
太空灰色廁紙架
建議零售價：\$450



8041SG
太空灰色廁紙架
建議零售價：\$360



8040SG
太空灰色毛巾架
建議零售價：\$360



8030SG
太空灰色毛巾架
建議零售價：\$450

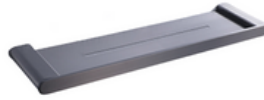

8050SG
太空灰色浴室置物架
建議零售價：\$550



8071SG
太空灰色掛勾毛巾架
建議零售價：\$690



7020SG
太空灰色單毛巾杆
建議零售價：\$530



7010SG
太空灰色雙毛巾杆
建議零售價：\$560



8020SG
太空灰色單毛巾杆
建議零售價：\$530



8010SG
太空灰色置物架
建議零售價：\$450



8002SG
太空灰色浴室角架
建議零售價：\$460



8003SG
太空灰色置物架
建議零售價：\$450



4SG
太空灰色4勾排勾
建議零售價：\$300
5SG
太空灰色5勾排勾
建議零售價：\$380
6SG
太空灰色6勾排勾
建議零售價：\$460

Accessories 浴室配件



2709PB
黑色單勾
建議零售價：\$190



205PB
黑色單勾
建議零售價：\$220



2710PB
黑色雙勾
建議零售價：\$220



305PB
黑色雙勾
建議零售價：\$220



9030PB
黑色單勾
建議零售價：\$190



9060PB
黑色面巾架
建議零售價：\$280



9061PB
黑色廁紙架
建議零售價：\$280



2708PB
黑色毛巾環
建議零售價：\$330



98105PB
黑色廁紙架
建議零售價：\$400



9020PB
黑色單毛巾杆
建議零售價：\$440



9010PB
黑色雙毛巾杆
建議零售價：\$600



9012PB
黑色毛巾架
建議零售價：\$1,020



Accessories 浴室配件



8041PB
黑色廁紙架
建議零售價：\$280



8030PB
黑色毛巾架
建議零售價：\$300



8020PB
黑色單毛巾杆
建議零售價：\$480



8010PB
黑色雙毛巾杆
建議零售價：\$520



8060PB
黑色毛巾架
建議零售價：\$720



8071PB
黑色掛勾毛巾架
建議零售價：\$690



98110PB
黑色雙廁紙架
建議零售價：\$480



98169PB
黑色毛巾及置物架
建議零售價：\$480



9080PB
黑色置物架
建議零售價：\$440



9082PB
黑色雙層置物架
建議零售價：\$1,120



4PB
黑色4勾排勾
建議零售價：\$240

5PB
黑色5勾排勾
建議零售價：\$300

6PB
黑色6勾排勾
建議零售價：\$360



BT4B
黑色4勾排勾
建議零售價：\$200

BT5B
黑色5勾排勾
建議零售價：\$260

BT6B
黑色6勾排勾
建議零售價：\$320

Accessories 浴室配件



105MG
拉絲金色單勾
建議零售價：\$190



205MG
拉絲金色單勾
建議零售價：\$240



2708MG
拉絲金色毛巾環
建議零售價：\$360



7080MG
拉絲金色廁紙架
建議零售價：\$360



8050MG
拉絲金色浴室置物架
建議零售價：\$550



7020MG
拉絲金色單毛巾杆
建議零售價：\$530



7010MG
拉絲金色雙毛巾杆
建議零售價：\$560



8060MG
拉絲金色毛巾架
建議零售價：\$1,020



8002MG
拉絲金色浴室角架
建議零售價：\$460



8003MG
拉絲金色置物架
建議零售價：\$450



Accessories

浴室配件



P04
銀色彈跳去水
有滿水位



P04BD
黑拉絲色彈跳去水
有滿水位



P04WL
砂鋼色彈跳去水
有滿水位



P04PB
黑色彈跳去水
有滿水位

P05
銀色彈跳去水
無滿水位

建議零售價：\$100

P05BD
黑拉絲色彈跳去水
無滿水位

建議零售價：\$190

P05WL
砂鋼色彈跳去水
無滿水位

建議零售價：\$190

P05PB
黑色彈跳去水
無滿水位

建議零售價：\$190



P04RG
玫瑰金色彈跳去水
有滿水位



P04MG
拉絲金色彈跳去水
有滿水位



P04CG
亮金色彈跳去水
有滿水位



P04WH
白色彈跳去水
有滿水位

P05RG
玫瑰金色彈跳去水
無滿水位

建議零售價：\$190

P05MG
拉絲金色彈跳去水
無滿水位

建議零售價：\$190

P05CG
亮金色彈跳去水
無滿水位

建議零售價：\$190

P05WH
白色彈跳去水
無滿水位

建議零售價：\$190



<http://wellbloom.com/>



FIND A RETAILER